



Tapered Short Guided system

Catalog & Surgical Manual

confidence in compromised sites

Tapered Short Implants

BioHorizons Tapered Short implants are available in 6 and 7.5mm lengths, offering a solution for cases with limited vertical bone height and minimizing the need for bone grafting. The implant design features an aggressive thread profile and tapered body for primary stability, even in compromised situations. A platform-switched, dual-affinity, Laser-Lok® surface offers crestal bone retention and a connective tissue attachment for flexible placement in uneven ridges. The Tapered Short Guided system offers a dedicated guided surgery solution for the Tapered Short implants, featuring keyless drills, new irrigation flutes and length specific drivers.

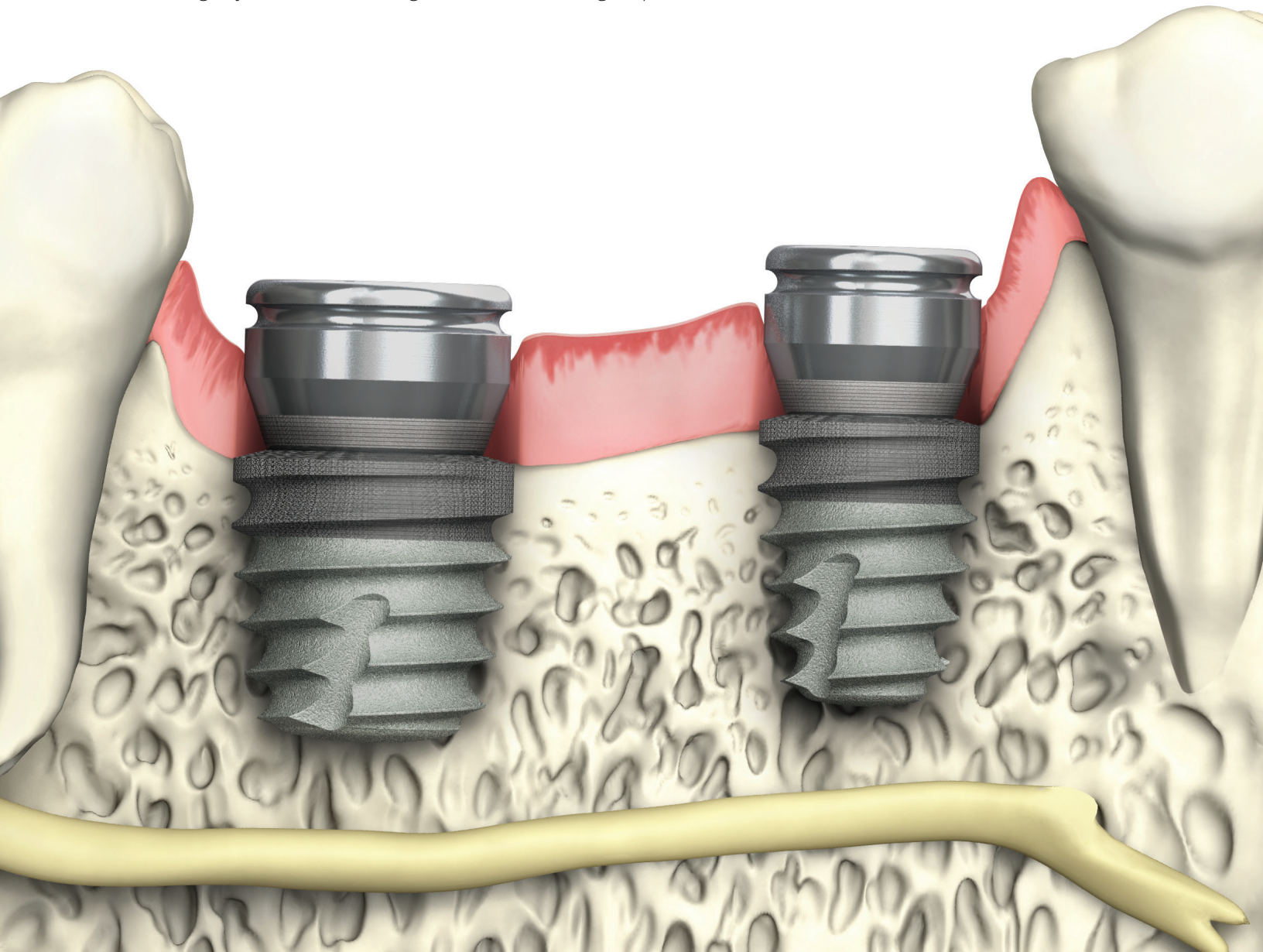

Tapered Short Guided System

Table of contents

Tapered Short Guided System	1-4
guided surgery process	5-6
guided surgery instruments	6-7
ancillary instruments	8
color coding	9
instructions for use	10
surgical kit & drill sequence	11
guide cylinders & surgery preparation	12-13
case example	14
surgical protocol	15
implant transfer & guided delivery	16-17
labeling, ordering & warranty information	18



Tapered Short Guided System

The BioHorizons Tapered Short Guided System offers a new approach to guided surgery, specifically designed for the Tapered Short implants. The updated instrument designs minimize stack height, while the keyless drill design simplifies the surgical workflow.



Tapered Short Guided System

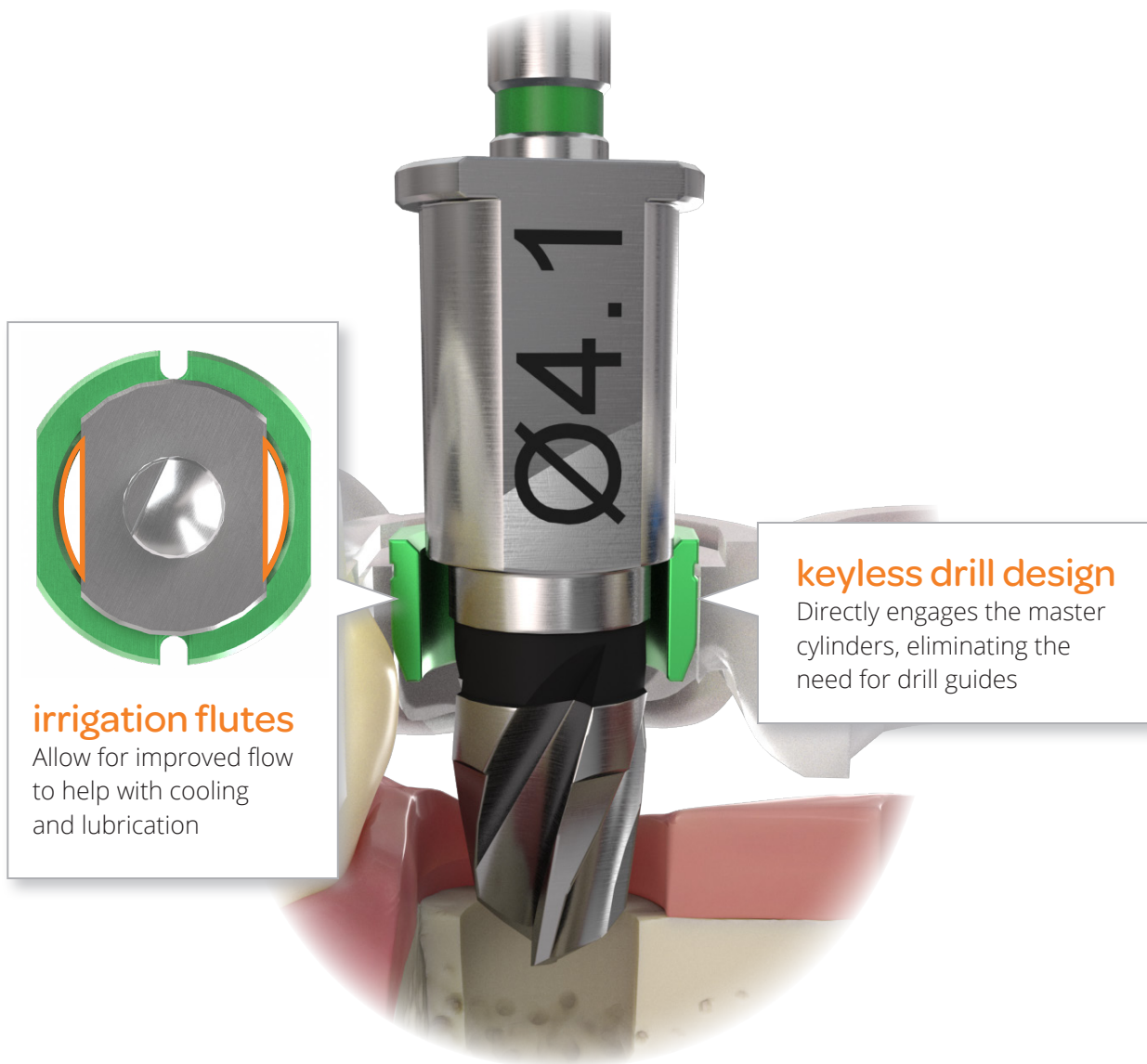

irrigation flutes

Allow for improved flow to help with cooling and lubrication

keyless drill design

Directly engages the master cylinders, eliminating the need for drill guides



length and diameter specific protocols

Provide complete guidance during the surgical workflow

Guided Surgery Process

Surgical Plan to Surgical Guide

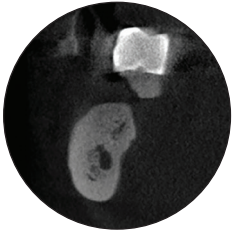

1. Clinical step - CT scan appointment

Initial patient records and CT scan. CT scan protocols will vary depending on the guide manufacturer. Guide manufacturer details are available at <https://biohorizons.com/Products/WorkflowPartners>



2. Clinical step - Treatment plan

Diagnose and treatment plan for guided surgery. Determine if adequate vertical space is available to accommodate the surgical guide and related components. Import CT scan data into the treatment planning software and design the case.

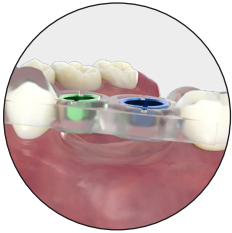

3. Guide manufacturer step - Guide fabrication

Guide manufacturer fabricates the surgical guide using the virtual treatment plan and BioHorizons master cylinders. A patient-specific surgical protocol is generated for the clinician to follow.



4. Clinical step - Guided surgery

Clinician performs the procedure using the surgical guide and the BioHorizons Tapered Short Guided kit while following the surgical protocol.



Guided Restorative Solutions

by Vulcan and BioHorizons

Guided Restorative Solutions (GRS) combines the efficiency and predictability of guided surgery, with hybrid or titanium custom abutments. GRS conveniently delivers everything needed for a case, including BioHorizons implants.

Learn more: www.vulcandental.com



The surgical guide must be fabricated using BioHorizons manufactured master cylinders and pilot sleeves. Please contact your guide manufacturer for further information.

Guided Surgery Instruments

Guided Surgery Kit

TSGKIT Tapered Short Guided Kit

Includes the instruments required to place BioHorizons Tapered Short Implants.

TSGT Tapered Short Guided Tray



design features include:

- keyless drill design
- depths marks allow for freehand use
- irrigation channels allow for improved cooling
- dedicated drivers for each implant
- simple, color-coded protocols

Individual Components



CGS-YTP 3.8mm CGS Tissue Punch

CGS-GTP 4.6mm CGS Tissue Punch



CGS-FP CGS Fixation Pin

3 included with kit



130-000 Ratchet



135-351 .050" (1.25mm) Hex Driver

Guided Surgery Instruments

Drills

Guided surgery drills with definitive depth stops follow the standard Tapered Short drill sequence and come in four different length/diameter combinations. The patient-specific surgical protocol that accompanies the surgical guide will indicate which drills to use.



	Drill #1	Drill #2	Drill #3	DB Drill
Ø 4.6mm	TSGG1	TSGG2	TSGG3	TSGGDB
Ø 5.8mm	TSGB1	TSGB2	TSGB3	TSGBDB

Screw-retained Implant Drivers

Screw-retained implant drivers are used to pickup and seat implants when used with a 4mm square ratchet. The driver is secured to the implant using the captured screw and can be easily released after implant placement. Use the depth stops to seat the implants to the planned depth. Orient the implant hex using the notches as a visual reference. The low profile of the screw-retained drivers minimizes stack height when vertical space is limited. These drivers can be used with a handpiece when using the 4mm Square Driver Converter.



- TSGG60** TSG Implant-level Driver, 4.6 x 6.0
- TSGG75** TSG Implant-level Driver, 4.6 x 7.5
- TSGB60** TSG Implant-level Driver, 5.8 x 6.0
- TSGB75** TSG Implant-level Driver, 5.8 x 7.5

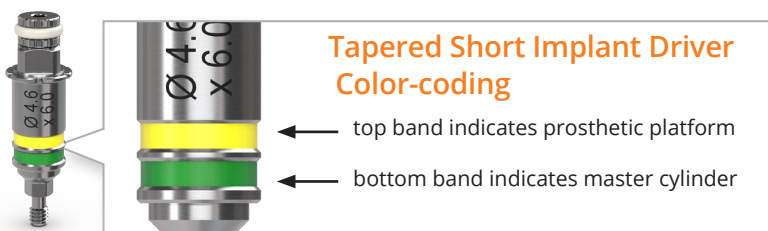

- CGS-4SC** 4mm Square Drive Converter
- Drive converter allows the screw-retained drivers to be used with a handpiece.

Ancillary Instruments (Sold Separately)

Driver Attachments



300-205

Ratchet & Hand Wrench Extender*

300-400

Hand Wrench

The driver attachments allow for the screw-retained drivers to be extended or used manually.

Implant Mount



CGS-IM

CGS Implant Mount

The implant mount provides additional surgical guide fixation. The mount is designed to pass through the surgical guide and screw into an implant that has already been placed; the thumb wheel is then tightened, fixing the guide in the patients' mouth.

.050" (1.25mm) Hex Drivers

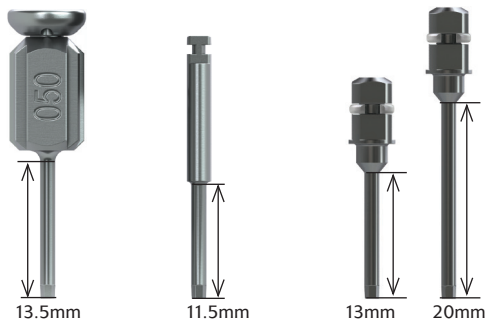

13.5mm

11.5mm

13mm

20mm

Manual

Handpiece

4mm Square

135-451

Manual Hex Driver, Long

134-450

Handpiece Hex Driver, Long

300-351

4mm Square Hex Driver, Long*

300-354

4mm Square Hex Driver, Extra Long*

For installation and removal of cover caps, prosthetic and abutment screws.

Torque Wrench



C12374

Elos Adjustable Torque Wrench

Lightweight titanium design is easy to use as an adjustable torque wrench or a ratchet. Quickly disassembles for cleaning. No calibration required.



C8521

Elos Replacement Bit, 4mm Square Driver

C8381

Elos Replacement Bit, Handpiece Driver

*Instrument o-rings & c-rings wear out over time. If an instrument is no longer held securely by its associated driver, order a replacement ring through Customer Care.

BioHorizons Tapered Short Implants

Color-coding for Tapered Short

BioHorizons implants can be delivered through the surgical guide for a fully guided workflow.

	TSL4606	TSL4607	TSL5806	TSL5807
implant size				
	4.6x6.0mm	4.6x7.5mm	5.8x6.0mm	5.8x7.5mm
Laser-Lok zone	1.8mm	1.8mm	1.8mm	1.8mm
apical diameter	3.7mm	3.7mm	4.9mm	4.9mm
master cylinder*				
prosthetic connection				
	3.5mm	3.5mm	4.5mm	4.5mm
Tapered Short Implant Drivers				
implant driver				
	4.6x6.0mm	4.6x7.5mm	5.8x6.0mm	5.8x7.5mm

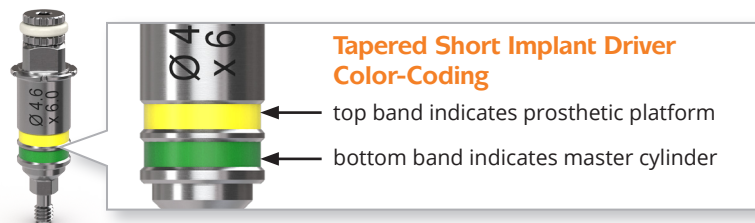

Tapered Short Guided Drivers are labeled on one side of the shaft with the corresponding implant diameter and length.

*Use of the TSGGMC-10 and TSGBMC-10 master cylinders are required for use with the TSGKIT and Tapered Short implant. The CGS master cylinders are not compatible with the Tapered Short Guided system.

Surgical Manual

Instructions for Use



This surgical manual serves as a reference for using the Tapered Short Guided Kit. It is intended solely to provide instructions on the use of BioHorizons products. It is not intended to describe the methods or procedures for diagnosis, treatment planning, or placement of implants, nor does it replace clinical training or a clinician's best judgment regarding the needs of each patient. BioHorizons strongly recommends appropriate training as a prerequisite for the placement of implants and associated treatment.

The procedures illustrated and described within this manual reflect idealized patient presentations with adequate bone and soft tissue to accommodate implant placement. No attempt has been made to cover the wide range of actual patient conditions that may adversely affect surgical and prosthetic outcomes. Clinician judgment as related to any specific case must always supersede any recommendations made in this or any BioHorizons literature.



Before beginning any implant surgical procedure using the BioHorizons Tapered Short Guided Kit:

- Read and understand the Instructions for Use that accompany the products.
- Clean and sterilize the surgical tray and instruments following the Instructions for Use.
- Become thoroughly familiar with all the instruments and their uses.
- Study the surgical kit layout and iconography.
- Design a surgical treatment plan to satisfy the prosthetic requirements of the case.

Indications

The Tapered Short Guided Kit is intended to facilitate the creation of an osteotomy for placement of BioHorizons Tapered Short implants using a surgical guide that incorporates BioHorizons manufactured Tapered Short Guided master cylinders. The bone cutting instruments are intended for use in the mandible or maxilla for partially and fully edentulous arches.

Surgical Manual

Surgical Kit & Drill Sequence

Surgical Kit Instructions

Prior to use, clean and sterilize the surgical tray and instruments according to the Instructions for Use. Study the kit layout, color-coding and iconography. Surgical assistants should be thoroughly familiar with all instruments and their uses prior to initiating the surgical procedure.

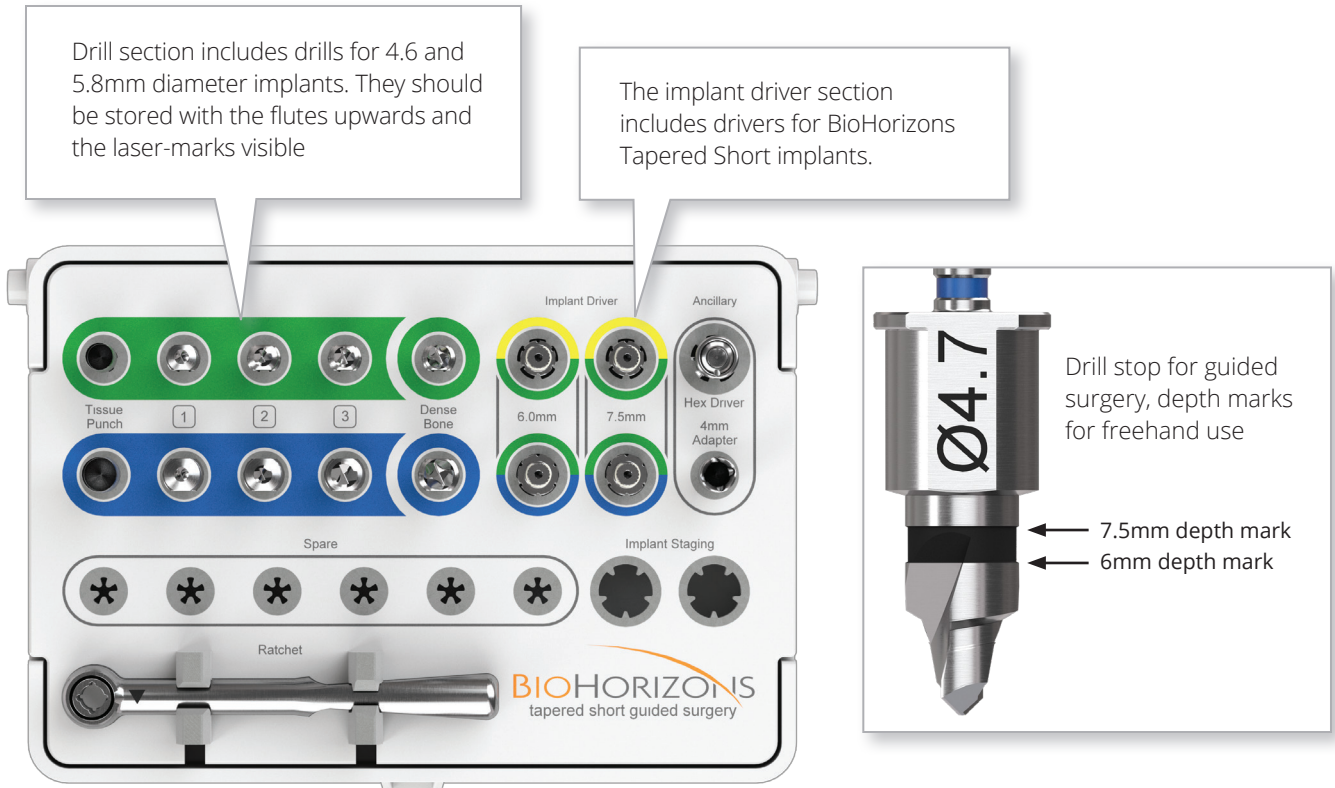

Drill Sequence

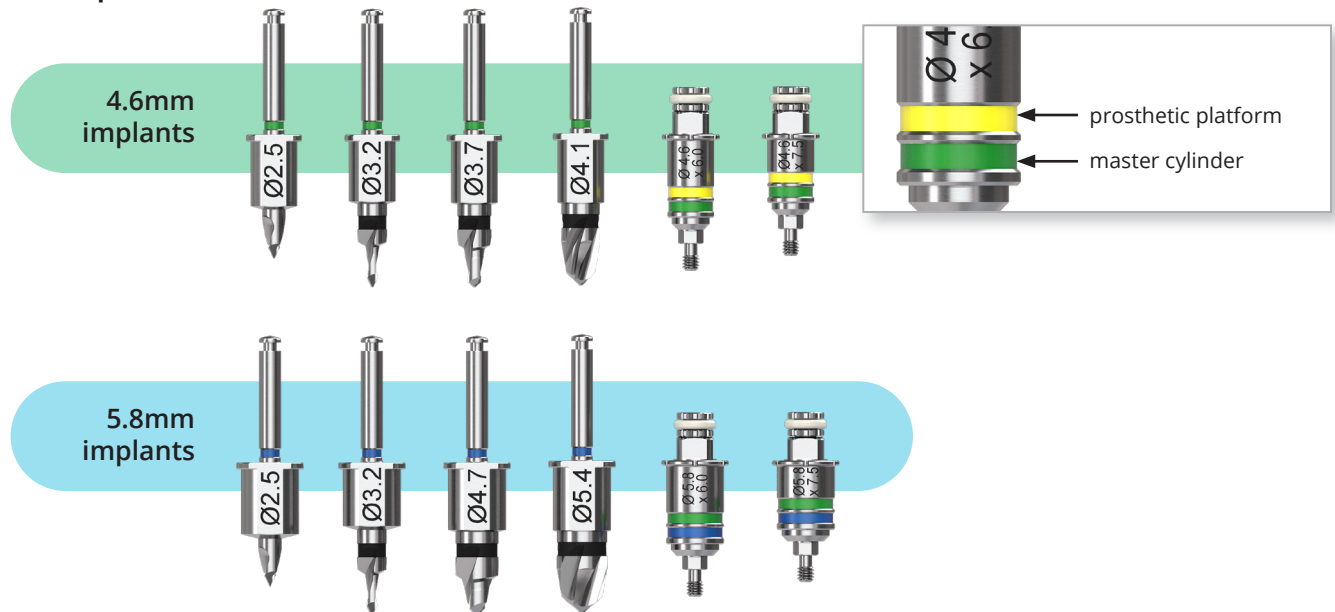

Surgical Manual

Guide Cylinders & Surgery Preparation

Master Cylinders (pack of 10)

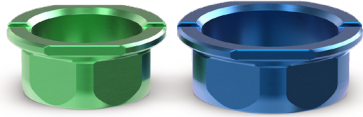

TSGGMC-10

TSG 4.6mm Master Cylinder (pack of 10)

TSGBMC-10

TSG 5.8mm Master Cylinder (pack of 10)

Pre-surgery Preparation

Inspect the surgical guide for defects and potential weak areas. Visually evaluate the position of the master cylinder to ensure it is placed according to the treatment plan.

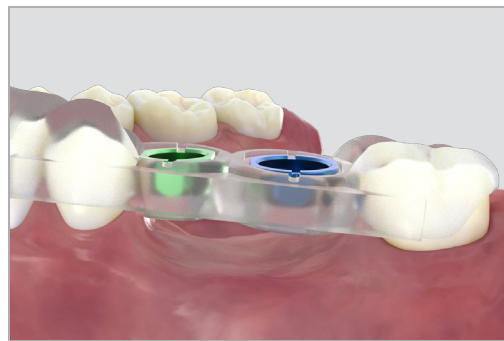

Ensure the thru-hole of the drill guides and master cylinders are free of debris.

The surgical guide must have a stable fit to the patient's anatomy. If a stable fit cannot be obtained at time of surgery, the surgical guide should not be used. Do not use excessive force to seat the surgical guide.

Review the surgical plan and instruments within the kit prior to surgery. Drill use should be cross-checked against the drill usage chart (ML0232). Any drills that are worn, marked or dull should be replaced.

Place the drill in the handpiece and check the fit with all the drill guides prior to surgery.

Screw-retained Driver Assembly

The screw-retained implant drivers are designed as a two piece assembly. If the part becomes disassembled during initial engagement of the implant or during removal from the implant after placement, please use the diagram to identify and reassemble the compatible parts.



6.0mm drivers of both diameters use the longer screw.

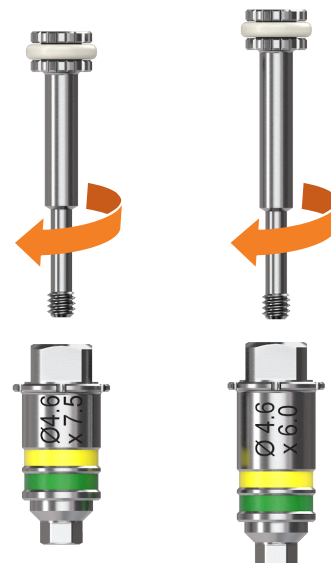

Surgical Manual

Surgery Preparation

Drilling Technique

Fully seat the drill into the master cylinder. Ensure the drill has a resistance free path of insertion by pumping the drill in-and-out of the drill guide prior to drilling.

Each drill should be advanced as far as possible through the master cylinder prior to initiating drilling.

Use short, light strokes to progressively advance the drills to depth with minimal pressure on the drills. Profuse irrigation throughout the drilling sequence is necessary to provide lubrication and prevent overheating.

Use an in-and-out pumping action (Figure 1) to help clear flutes of any bone debris. Drills should not be completely removed from master cylinders during pumping. When finally removing drills from master cylinders the drill should not be rotating.

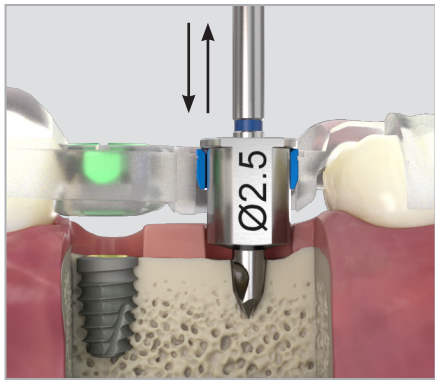

Avoid applying lateral pressure to the master cylinder by ensuring the drill path is in line with the master cylinder.

Suction and irrigation should be used between drills to remove debris from the instruments, master cylinders and the osteotomy.

Warning: Failure to follow these steps can cause the drills to bind in the master cylinders.

Master Cylinder Position Reference

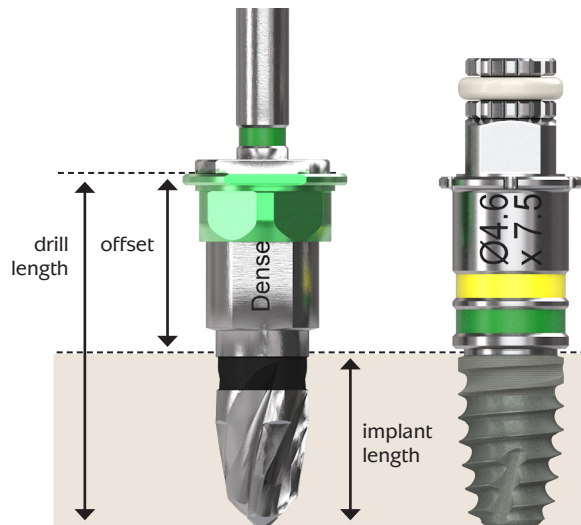

Surgical Manual



Guided Surgery Case Example

Placing a 5.8mm x 7.5mm Tapered Short Implant

A patient-specific surgical protocol should be included with the surgical guide. The surgical protocol includes the recommended components to be used for each implant site. Verify the protocol corresponds to the submitted virtual treatment plan prior to surgery.

Clinician judgment must always supersede any recommendations in the surgical protocol and any BioHorizons Instructions for Use.



implant label	28	29
implant type	TSL4607	TSL5807
implant length	7.5mm	7.5mm
guide site	Complete	Complete
implant site preparation		
drill	#1 (2.5mm)	#1 (2.5mm)
drill	#2 (3.2mm)	#2 (3.2mm)
drill	#3 (3.7mm)	#3 (4.7mm)
drill	DB (4.1mm)	DB (5.4mm)
guided implant placement		
implant driver	 4.6 x 7.5	 5.8 x 7.5

2300 Riverchase Center • Birmingham, Alabama 35244 • corporate: 866.872.9785 or 205.967.7880 • fax: 205.870.0304
BioHorizons products are available in 90 countries throughout the world • www.biohorizons.com

Important Considerations

- Peri-operative oral rinses with a 0.12% Chlorhexidine Digluconate solution have been shown to significantly lower the incidence of post-implantation infectious complications.² A pre-operative 30-second rinse is recommended, followed by twice daily rinses for two weeks following surgery.
- Drilling must be done under a constant stream of sterile irrigation. A pumping motion should be employed to prevent over-heating the bone. Surgical drills should be replaced when they are worn, dull, corroded or in any way compromised. BioHorizons recommends replacing drills after 12 to 20 osteotomies.³ A Drill-usage Tracking Chart is available at biohorizons.com to record this important information.
- There is a risk of injury to the mandibular nerve associated with surgical drilling in posterior mandibular regions. To minimize the risk of nerve injury, it is imperative that the clinician understands the virtual treatment plan created and ensures the surgical guide corresponds to the clinician's virtual treatment plan.

Surgical Manual

Surgical Protocol

Tissue Punch & Drill #1 (Pre-drill)

- The tissue punch provides an optional first step for a flapless procedure
- Select Drill #1
- Insert the drill in the master cylinder and use short, light strokes to progressively advance the drill until the depth stop rests on the master cylinder

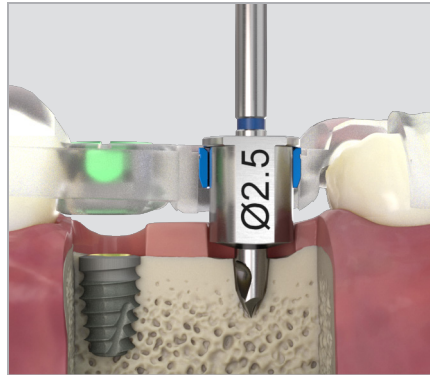
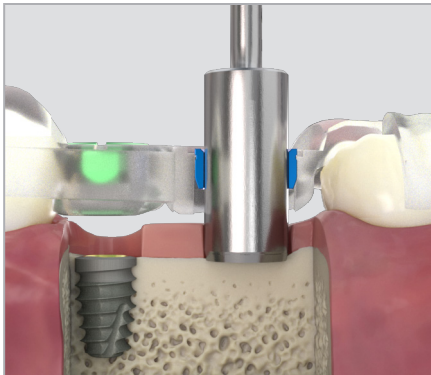

Drill #2 & 3 (Step Drills)

- Incrementally widen the osteotomy
- Continue through the drill sequence using the specified drills

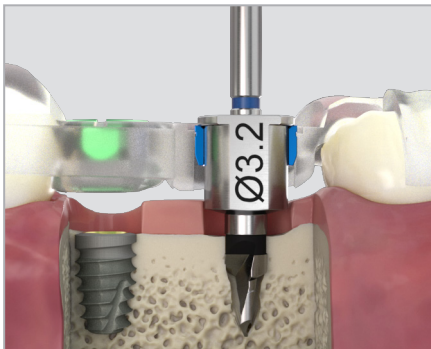

Dense Bone Drill

- Finalize the osteotomy using the optional dense bone drill

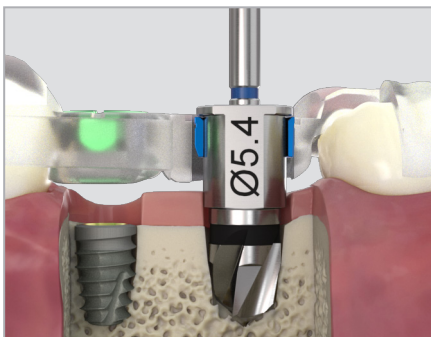

Surgical Manual

Implant Transfer & Guided Delivery

Mount-free Transfer

Vial caps are a surgical reference and are color-coded to indicate body diameter (4.6mm=green, 5.8mm=blue). Implant drivers are color-coded by prosthetic platform (3.5mm=yellow, 4.5mm=green) for proper mating with the implant connection.

Length specific drivers are used in place of depth stops or stop position. Reference the patient-specific surgical protocol for the required implant driver.



Engage the implant with screw-retained driver by inserting the driver into the implant platform and tightening the screw. The driver can then be picked up with a handpiece by using the converter (CGS-4SC) or manually using a ratchet.



The cover cap for a two-stage surgical protocol is mounted in the vial cap.

Guided Implant Delivery

A handpiece or ratchet can be used to place the implant through the master cylinder.



- Ensure the shaft of the implant driver is properly aligned with the master cylinder
- Place the 5.8mm x 7.5mm implant through the master cylinder
- If using a ratchet, an extender may be required to avoid collision with adjacent anatomy

Surgical Manual

Implant Transfer & Guided Delivery

Screw-retained Driver Hex Orientation

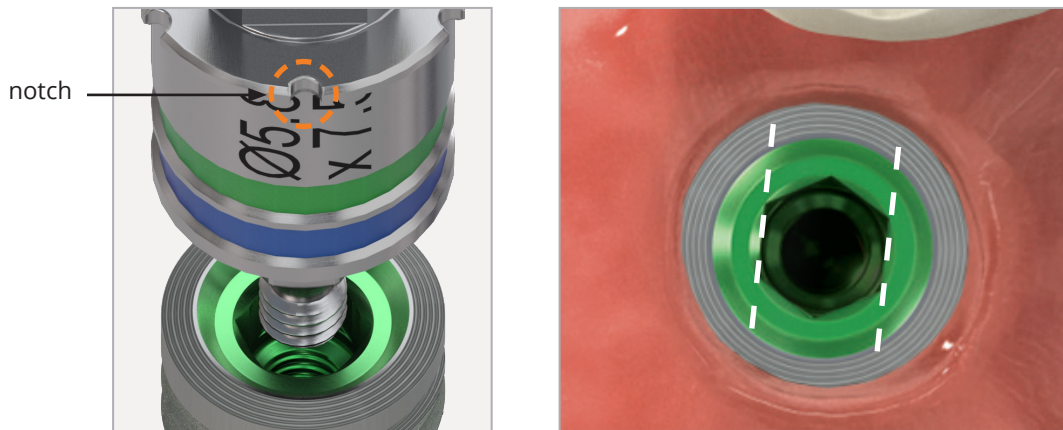

Orient the hex when using a ratchet or handpiece.

When seating the implant with a ratchet, use the corresponding notches on the driver to orient one internal hex flat perpendicular to the implant angulation plane.

Post-operative Instructions

A period of unloaded healing time is often recommended to allow for integration between the bone and implant surface. This is dependent on individual patient healing rates and bone quality of the implant site. Each case must be independently evaluated.

The patient should be instructed to follow a post-surgical regimen including cold packs for 24 hours post-implantation. The patient's diet should consist of soft foods and possibly dietary supplements. Pharmacological therapy should be considered as the patient's condition dictates.

If a removable prosthesis is used during the initial healing phase, a soft liner material should be used to prevent pressure on the surgical site. Relieve the prosthesis over the implant site prior to the soft liner application. Periodically check the patient's soft tissue and bone healing using clinical and radiographic evaluations.

Ongoing hygiene for the implant patient is vital. Hygiene recall appointments at three month intervals are suggested. Instruments designed for implant abutment scaling, such as Implacare® instruments from Hu-Friedy® should be utilized. The stainless steel handles may be fitted with assorted tip designs for hygiene on natural teeth. The Implacare® scalers contain no glass or graphite fillers that can scratch titanium implant abutments.

LABELING, ORDERING & WARRANTY INFORMATION

Symbol Descriptions for Product Labeling

LOT Lot/batch number

REF Reference/article number

EC REP
EU Authorised Representative
Quality First International OÜ
Laki 30
12915 Tallinn
Estonia
Tel +372-610-4196

BIOHORIZONS®

Tapered Guided Surgery Kit

manufactured by: **BioHorizons**
2300 Riverchase Center
Birmingham, AL 35244 USA
TEL +205-967-7880

REF TSGKIT

LOT YYXXXXX

YYYY-MM-DD
manufacture date

EC REP EU Authorised Representative
QUALITY FIRST INTERNATIONAL OÜ
Laki 30
12915 Tallinn
Estonia
Tel +372-610-4196

(01) 00847236009328
(11) YYMMDD
(10) YYXXXXX

MD

CE 2797

Rx Only

Non-Sterile

see instructions for use
<http://ifu.biohorizons.com>

see instructions for use
<http://ifu.biohorizons.com>

Non-Sterile Non-sterile

Artwork label number

CE 2797 BioHorizons products carry the CE mark and fulfill the requirements of the Medical Devices Directive 93/42/EEC

Rx Only
Caution: Federal (USA) law restricts these devices to the sale, distribution and use by, or on the order of, a dentist or physician.

BioHorizons Lifetime Warranty on Implants and Prosthetics for clinicians: All BioHorizons implants and prosthetic components include a Lifetime Warranty. BioHorizons implant or prosthetic components will be replaced if removal of that product is due to failure (excluding normal wear to overdenture attachments).

Additional Warranties: BioHorizons warranties surgical drills, taps and other surgical and restorative instruments.

(1) Surgical Drills and Taps: Surgical drills and taps include a warranty period of ninety (90) days from the date of initial invoice. Surgical instruments should be replaced when they become worn, dull, corroded or in any way compromised. Surgical drills should be replaced after 12 to 20 osteotomies.¹

(2) Instruments: The BioHorizons manufactured instrument warranty extends for a period of one (1) year from the date of initial invoice. Instruments include drivers, implant site dilators and BioHorizons tools used in the placement or restoration of BioHorizons implants.

Return Policy: Product returns require a Return Authorization Form, which may be acquired by contacting Customer Care. The completed Return Authorization Form must be included with the returned product. For more information, please see the reverse side of the invoice that was shipped with the product.

Disclaimer of Liability: BioHorizons products may only be used in conjunction with the associated original components and instruments according to the Instructions for Use (IFU). Use of any non-BioHorizons products in conjunction with BioHorizons products will void any warranty or any other obligation, expressed or implied.

Treatment planning and clinical application of BioHorizons products are the responsibility of each individual clinician. BioHorizons strongly recommends completion of postgraduate dental implant education and adherence to the IFU that accompany each product. BioHorizons is not responsible for incidental or consequential damages or liability relating to use of our products alone or in combination with other products other than replacement or repair under our warranties.

Distributed Products: For information on the manufacturer's warranty of distributed products, please refer to their product packaging. Distributed products are subject to price change without notice.

Validity: Upon its release, this literature supersedes all previously published versions.

Availability: Not all products shown or described in this literature are available in all countries. BioHorizons continually strives to improve its products and therefore reserves the right to improve, modify, change specifications or discontinue products at any time.

Any images depicted in this literature are not to scale, nor are all products depicted. Product descriptions have been modified for presentation purposes. For complete product descriptions and additional information, visit store.biohorizons.com.

1. Implant success rate is the weighted average of all published human studies on BioHorizons implants. These studies are available for review in BioHorizons document numbers ML0606 and ML0130.
2. The influence of 0.12 percent chlorhexidine digluconate rinses on the incidence of infectious complications and implant success. Lambert PM, Morris HF, Ochi S. *J Oral Maxillofac Surg* 1997;55(12 supplement 5):25-30.
3. Heat production by 3 implant drill systems after repeated drilling and sterilization. Chacon GE, Bower DL, Larsen PE, McGlumphy EA, Beck FM. *J Oral Maxillofac Surg*. 2006 Feb;64(2):265-9.

Direct Offices

BioHorizons USA
888-246-8338 or 205-967-7880

BioHorizons Canada
866-468-8338

BioHorizons Spain
+34 91 713 10 84

BioHorizons UK
+44 (0)1344 752560

BioHorizons Chile
+56 (2) 23619519

BioHorizons Italy
800-063-040

BioHorizons Mexico
800-953-0498

Distributors

For contact information in our 90 countries, visit biohorizons.com



shop online at
store.biohorizons.com

BioHorizons®, Laser-Lok®, MinerOss®, AutoTac®, Mem-Lok® and TeethXpress® are registered trademarks of BioHorizons. Unigrip™ is a trademark of Nobel Biocare AB. Zimmer® Dental ScrewVent® and Tapered ScrewVent® are registered trademarks of Zimmer, Inc. AlloDerm™, AlloDerm GBR™ and NovoMatrix™ are trademarks of LifeCell Corporation, an Allergan affiliate. Grafton® DBM is a registered trademark of Medtronic, Inc. Cytoplast® is a registered trademark of Osteogenics Biomedical, Inc. Puros Dermis is a registered trademark of Zimmer Biomet. Mucograft is a registered trademark of Ed. Geistlich Sogne Ag Fur Chemische Industrie. Symbios PerioDerm is a registered trademark of Dentsply Sirona. Hu-Friedy® is a registered trademark of Hu-Friedy Mfg. Co., LLC. Spiralock® is a registered trademark of Spiralock Corporation. Pomalux® is a registered trademark of Westlake Plastics Co. Locator® is a registered trademark of Zest Anchors, Inc. Delrin® is a registered trademark of E.I. du Pont de Nemours and Company. Bio-Gide® is a registered trademark of Edward Geistlich Sohne AG Fur Chemische Industrie. BioMend® is a registered trademark of Zimmer Biomet Dental. IntraSpin®, L-PRF® and Xpression® are trademarks of Intra-Lock® International Inc. Not all products shown or described in this literature are available in all countries. As applicable, BioHorizons products are cleared for sale in the European Union under the EU Medical Device Directive 93/42/EEC and the tissues and cells Directive 2004/23/EC. We are proud to be registered to ISO 13485:2016, the international quality management system standard for medical devices, which supports and maintains our product licences with Health Canada and in other markets around the globe. Original language is English. ©BioHorizons. All Rights Reserved.



L02066



REV A NOV 2020